

# Clarke®



## 3KVA PETROL GENERATOR

MODEL NO: PG3800A

PART NO: 8857852

## OPERATION & MAINTENANCE INSTRUCTIONS



DL0123

---

## INTRODUCTION

---

Thank you for purchasing this CLARKE 3kVA Petrol Generator.

Before attempting to use this product, please read this manual thoroughly and follow the instructions carefully. In doing so you will ensure the safety of yourself and that of others around you, and you can look forward to your purchase giving you long and satisfactory service.

---

## GUARANTEE

---

This product is guaranteed against faulty manufacture for a period of 12 months from the date of purchase. Please keep your receipt which will be required as proof of purchase.

This guarantee is invalid if the product is found to have been abused or tampered with in any way, or not used for the purpose for which it was intended.

Faulty goods should be returned to their place of purchase, no product can be returned to us without prior permission.

This guarantee does not effect your statutory rights.

---

## ENVIRONMENTAL RECYCLING POLICY

---



Through purchase of this product, the customer is taking on the obligation to deal with the WEEE in accordance with the WEEE regulations in relation to the treatment, recycling & recovery and environmentally sound disposal of the WEEE.

In effect, this means that this product must not be disposed of with general household waste. It must be disposed of according to the laws governing Waste Electrical and Electronic Equipment (WEEE) at a recognised disposal facility.

---

# GENERAL SAFETY RULES

---



**WARNING: EXHAUST FUMES CAN BE EXTREMELY DANGEROUS IF INHALED**

---

## WORK AREA

- *Always use in a well ventilated area.*
- *Always position the exhaust outlet away from people.*
- *Never use indoors or in a confined space.*
- **Read these safety instructions before using the equipment.**
- **Keep children away from the generator.**

## POSITIONING THE GENERATOR

1. **Always** leave a least a 1m gap between the generator and any surrounding building or structures.
2. **Always** ensure the generator is on a solid, flat surface.
3. **Always** ensure the surrounding area is free from any material that could burn or be damaged by heat.
4. **Never** move or tilt the generator whilst it is switched on.

## FIRE PREVENTION

1. **Always** switch the engine OFF when refuelling.
2. **Always** refuel away from any source of heat.
3. **Always** refuel in a well ventilated area.
4. Only use standard unleaded petrol.
5. **Never** smoke whilst refuelling and avoid smoking or using a naked flame near the generator.
6. **Never** start the engine if there is spilled fuel. Any spillage must be wiped clean and the generator allowed to dry before attempting to start the engine.







## PREVENTION OF ELECTRIC SHOCK

1. **Never** use the generator in wet conditions unless it is well protected/ covered. Under these conditions, adequate ventilation **MUST** be provided.
2. **Never** operate the generator with wet hands.
3. **Never** use water or any other liquids to clean the generator.

## ADDITIONAL SAFETY RULES FOR GENERATORS

1. **Always** ensure the applied load does not exceed the generator rating. Overloading the generator is dangerous and could cause serious damage.
2. **Always** disconnect the generator when carrying out any maintenance.
3. **Always** ensure the generator reaches operating speed before connecting a load.
4. **Never** allow the generator to run out of fuel when a load is connected.
5. **Never** transport the generator with fuel in the tank.
6. **Do Not** connect to a commercial or residential power supply; e.g. ring main.
7. **Never** allow the generator air vents to become blocked.

## SAFETY SYMBOLS

	Read Instruction manual before use		Flammable
	Caution - The user should be aware of a general hazard		Hot Surface - Do not touch
	Dangerous voltage		Poisonous fumes - Do not use the generator in an enclosed space.

# GENERATOR OVERVIEW

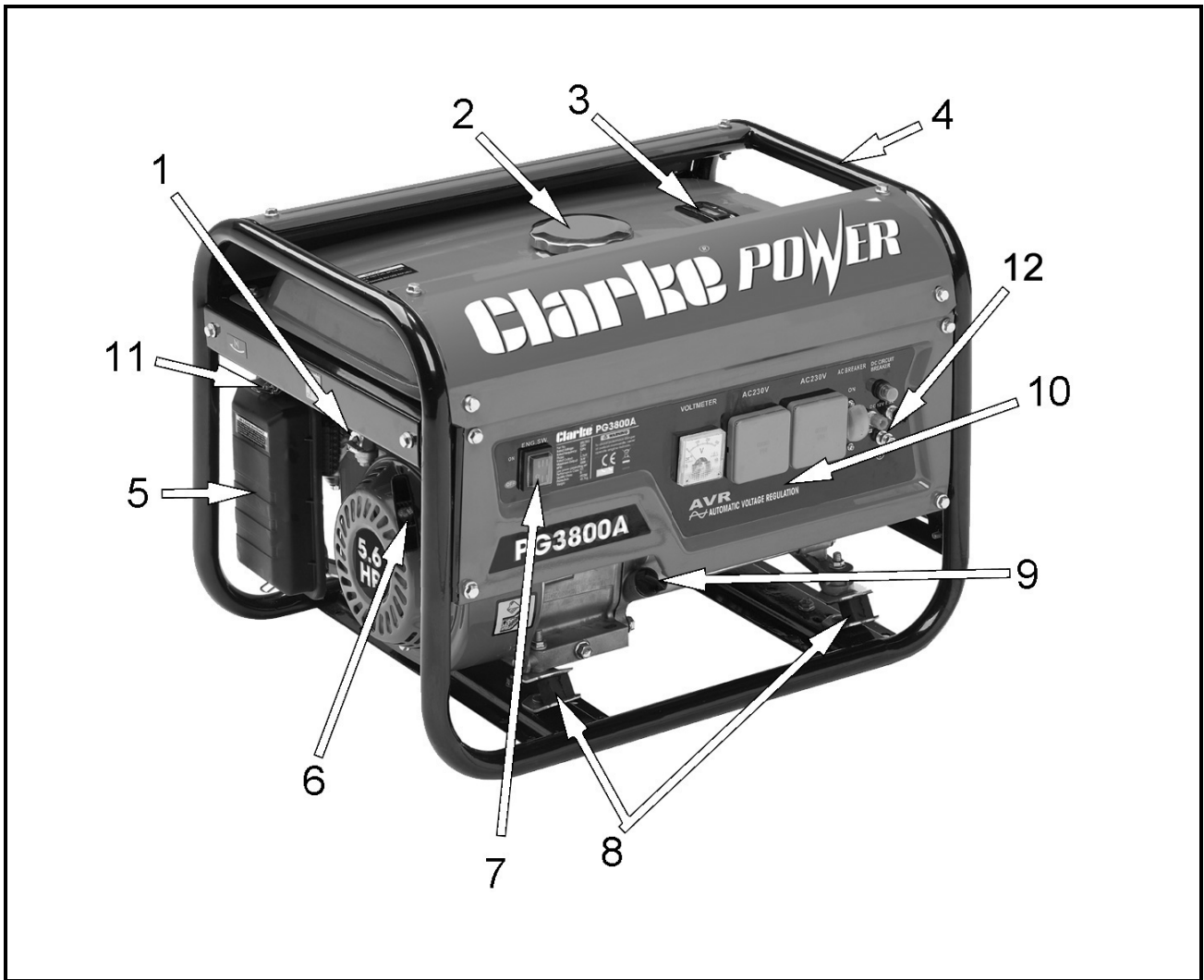

NO	DESCRIPTION	NO	DESCRIPTION
1	Fuel Supply Valve	7	Engine Switch
2	Fuel Tank Cap	8	Anti-vibration Feet
3	Fuel Level Gauge	9	Dipstick
4	Frame	10	Control Panel
5	Air Filter	11	Choke Lever
6	Starting Handle	12	Earth Point

---

## UNPACKING AND ASSEMBLY

---

Unpack your generator and check to ensure the following items are present. Should there be any deficiency or damage caused during transit contact your CLARKE dealer immediately.

<ul style="list-style-type: none"><li>• The generator</li></ul>	<ul style="list-style-type: none"><li>• Spark plug box spanner</li></ul>
<ul style="list-style-type: none"><li>• Tommy bar</li></ul>	<ul style="list-style-type: none"><li>• 12 Volt D.C. output lead assembly</li></ul>

---

## BEFORE USING THE GENERATOR

---

Attach a suitable earth lead to a good earthing point - water pipe, ground spike etc., whenever you use this generator.

Before using your generator check that:

- The generator is in good condition and free from any damage.
- The generator is clean and free from fuel or oil spillage.
- The generator is correctly located for use (See page 3).
- The fuel system is intact and there is no leakage.

**NOTE:** Always use a funnel to fill the fuel tank to avoid accidental spillage of fuel. If fuel is spilled it must be cleaned up before use.



**WARNING: ENSURE THERE IS ADEQUATE FUEL IN THE TANK WHEN USING THE GENERATOR. RUNNING OUT OF FUEL OR STOPPING THE ENGINE SUDDENLY WITH A LOAD CONNECTED COULD CAUSE SERIOUS DAMAGE.**

---

## EARTH POINT



**WARNING: FAILURE TO PROPERLY GROUND THE GENERATOR CAN RESULT IN ELECTROCUTION**

1. Ground the generator by connecting a suitable grounding wire to the earth point.

**NOTE:** Connect the other end of the grounding wire to a copper or brass grounding rod that is driven into the earth.

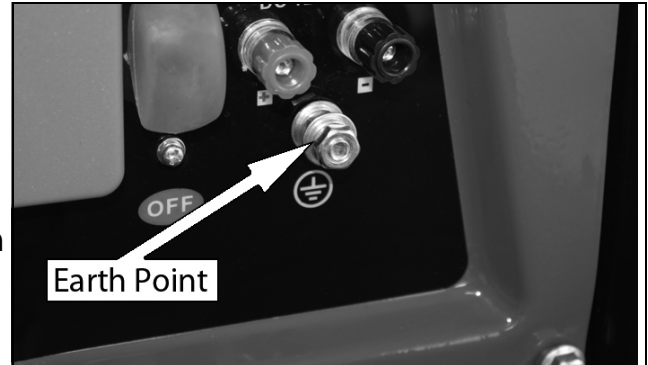

## CHECKING THE ENGINE OIL LEVEL



**WARNING: TO CARRY OUT THIS CHECK, PLACE THE GENERATOR ON LEVEL GROUND WITH THE ENGINE SWITCHED OFF.**

**WARNING: TAKE CARE NOT TO TOUCH ANY HOT PARTS OF THE GENERATOR WHEN CHECKING THE OIL LEVEL.**

1. Turn the dipstick anti-clockwise and remove from the oil fill tube.
2. Wipe the dipstick with a clean cloth.
3. Insert the dipstick back into the oil fill tube and then remove it again. Do not screw in the oil filler cap/ dipstick when doing this.
4. If the oil level is at or below the 'L' mark on the dipstick, add oil to the crankcase.
  - Fill until the oil reaches the threads in the oil fill tube.
  - Oil capacity (See page 20).
  - We recommend the use of SAE15W40 oil in this generator. available from your CLARKE dealer.
5. Replace the oil filler cap.

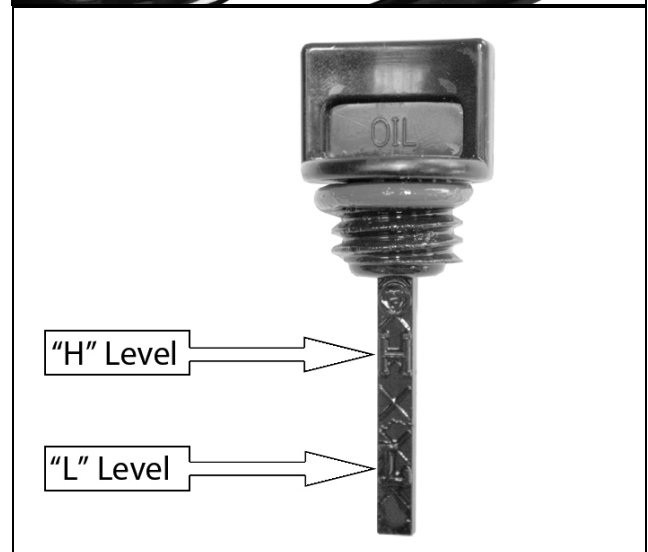
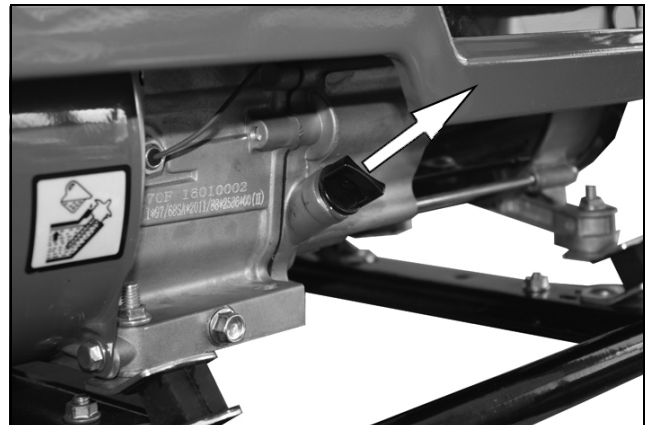



## CHECKING THE FUEL LEVEL

1. Check the fuel level on the fuel gauge.

The fuel gauge will show as red when you have fuel in the tank turning white as the fuel level decreases.



2. To add fuel, open the fuel filler cap.

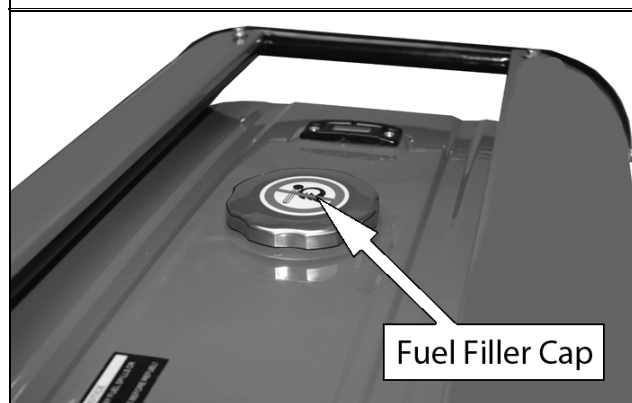

3. Just inside the fuel tank is a fuel filter which catches any contaminants as you refuel.
4. Slowly add fuel to the fuel tank (maximum 15L) watching the fuel level gauge as you do so.



### RECOMMENDED FUEL

We recommend the use of standard unleaded petrol.



**WARNING: ALWAYS REFUEL IN A WELL VENTILATED AREA AWAY FROM ANY HEAT SOURCES.**

**WARNING: ALLOW THE UNIT TO COOL DOWN BEFORE REFUELLING.**

**WARNING: DO NOT LEAVE FUEL WITHIN THE REACH OF CHILDREN.**

**NOTE:** Do not overfill the fuel tank.

5. Replace the fuel filler cap securely.

# USING YOUR GENERATOR

## STARTING THE ENGINE

1. Remove all connections from the AC sockets.
2. Set the fuel valve to the ON position as shown.
3. Make sure that the AC breaker is set to the off (down) position.
4. Move the choke lever to the 'Choke' position.
5. Set the engine switch to 'ON'.

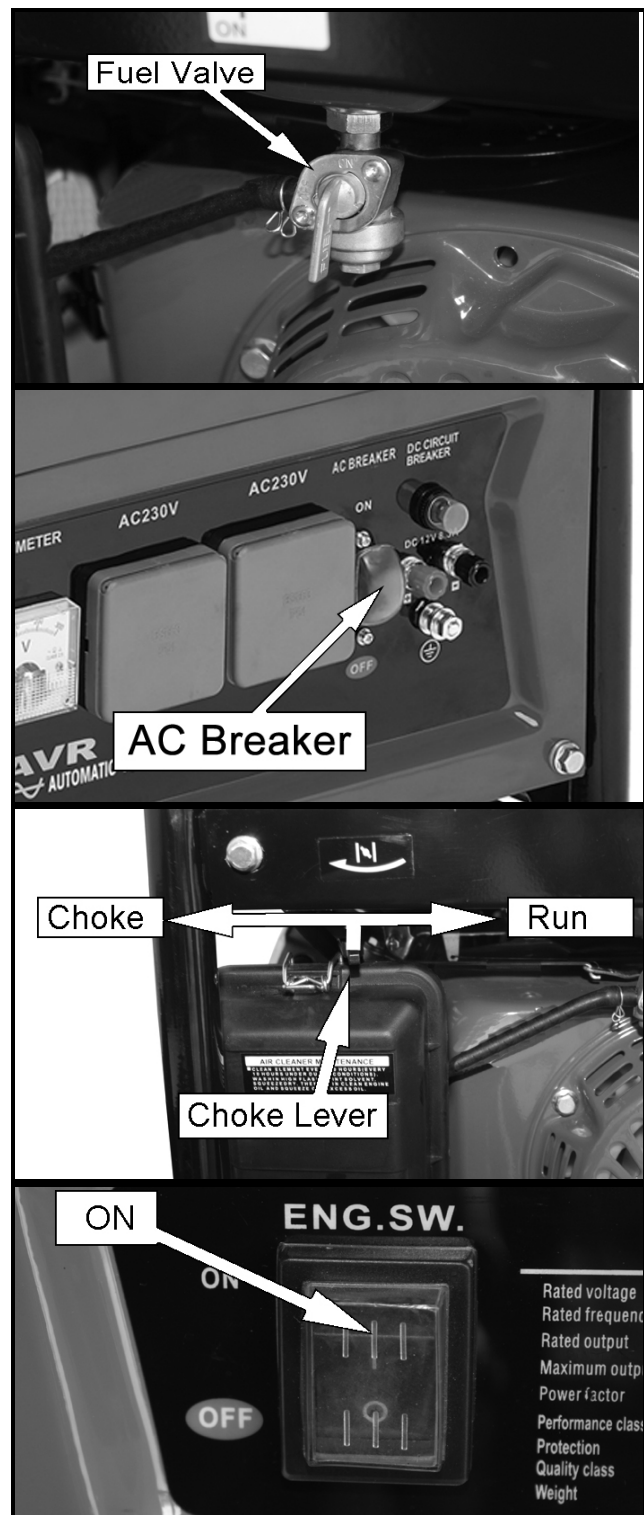

6. Hold the generator steady and pull the starting handle lightly until you start to feel resistance. Then pull sharply to start the engine.

**NOTE:** You may have to do this more than once.

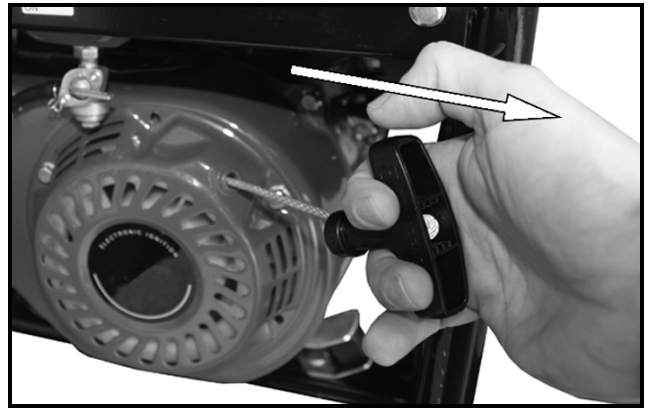

**WARNING: ONCE THE GENERATOR HAS STARTED, RELEASE THE STARTING HANDLE SLOWLY TO AVOID INJURY/DAMAGE AS IT RECOILS.**

**NOTE:** When you first start the generator, the overload indicator may light up for a few seconds, this is normal. If the overload indicator is still lit after 5 seconds, stop the engine and contact your CLARKE dealer.

7. Once the engine has warmed up, move the choke lever to the "run" position.

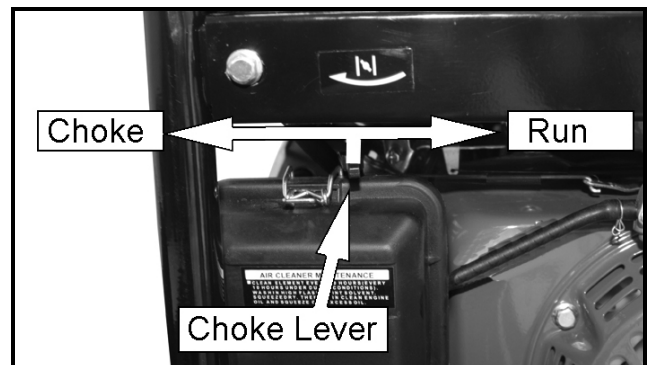

## CONNECTING ELECTRICAL APPLIANCES

The generator can supply both 230V AC and 12V DC

### AC POWER

1. Start the engine. See page 10
2. Make sure that the AC Breaker is set to the ON (up) position.
3. Connect the appliance to the generator.
  - Make sure the appliance is turned off before connecting it to the generator.
  - The voltage being supplied is shown on the voltmeter.

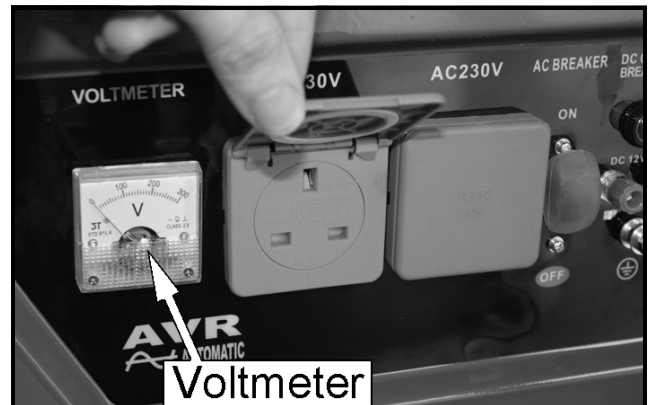

### AC BREAKER

The AC Breaker will activate if the generator is overloaded, If the AC Breaker activates,

1. Remove any connected devices from the generator
2. Wait for a few minutes
3. Set the AC breaker to the ON (up) position.
4. Reconnect the devices to the generator, making sure you do not exceed the maximum capacity of the generator.

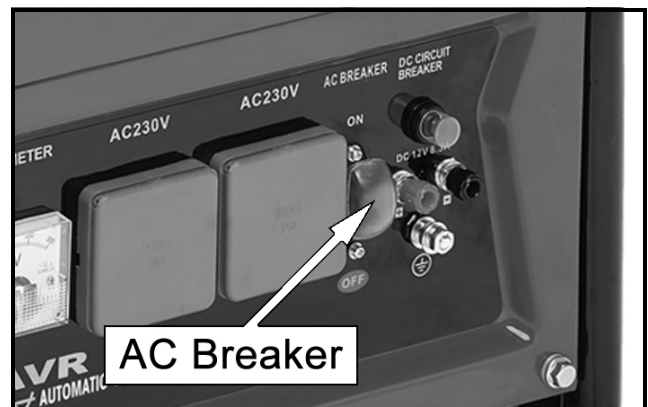

CAUTION: MAKE SURE THAT THE APPLIANCE BEING CONNECTED IS IN GOOD WORKING ORDER, IF IT BEGINS TO ACT ABNORMALLY OR STOPS SUDDENLY, DISCONNECT IT FROM THE GENERATOR

CAUTION: MAKE SURE THE APPLIANCE DOES NOT EXCEED THE MAXIMUM RATED LOAD FOR THE GENERATOR.

CAUTION: ANY DEVICE WHICH CONTAINS AN INDUCTIVE LOAD E.G. DEVICES THAT CONTAIN A MOTOR MAY REQUIRE MORE CURRENT ON STARTUP.

## DC POWER

1. Start the generator. See page 10
2. Make sure the appliance is turned off before connecting it to the generator.
3. Connect the 12V DC appliance (max 8.3A) to the generator.

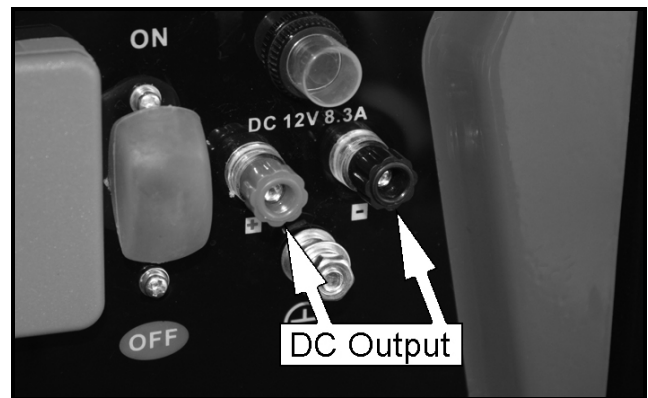

## DC POWER (CHARGING CAR BATTERIES)



**WARNING: FOR YOUR SAFETY PERFORM THE FOLLOWING INSTRUCTIONS IN THE ORDER SHOWN.**

**WARNING: YOU SHOULD ONLY USE THIS GENERATOR TO 'TOP UP' THE BATTERY, ALSO TRYING TO CHARGE A COMPLETELY FLAT BATTERY MAY CAUSE THE FUSE TO BLOW.**

1. Start the generator. See page 10
2. Connect the battery charging leads to the battery.
  - Make sure you clamp the red wire to the positive (+) terminal and the black wire to the negative (-) terminal of the battery.
3. Connect the battery charging leads to the generator.
  - The battery will begin to charge
4. Monitor the voltage across the battery regularly during charging and disconnect the battery when the voltage reaches 14.4 volts.
  - Do not allow the clamps to touch each other whilst connected to the generator.



**CAUTION: WHEN DISCONNECTING THE BATTERY, ALWAYS DISCONNECT THE NEGATIVE (BLACK) LEAD FIRST.**

## DC OVERLOAD PROTECTOR

If the DC overload protector activates, wait for a few minutes and then press the reset button shown on the right.

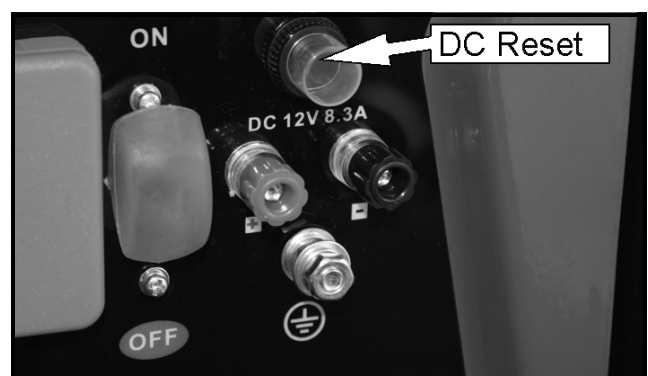

## SHUTTING DOWN THE GENERATOR

To stop the generator in an emergency simply set the engine switch to 'OFF'.

**NOTE:** Turn off any electric devices.

1. Disconnect any electric devices.
2. Make sure that the AC breaker is set to the off (down) position.
3. Set the engine switch to the "0" (OFF) position.
4. Set the fuel valve to the OFF position as shown."

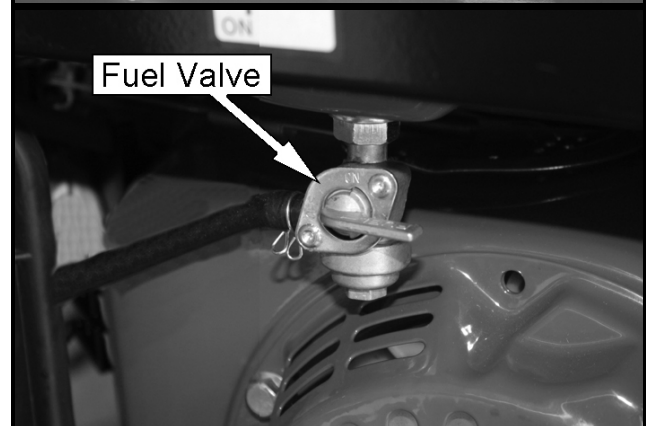
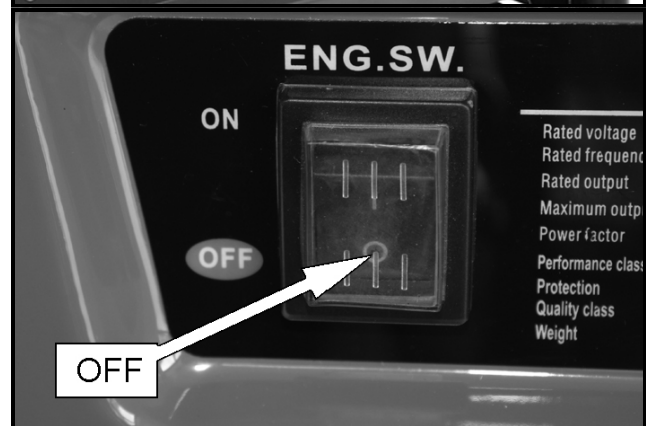
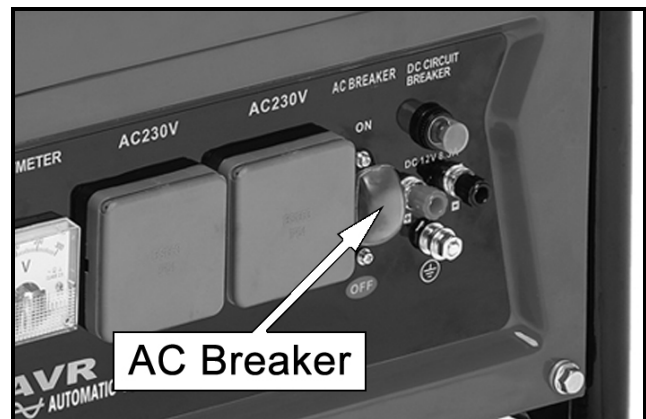

# MAINTENANCE

## CHANGING THE ENGINE OIL



CAUTION: PROLONGED EXPOSURE TO USED ENGINE OIL IS DANGEROUS, ALWAYS WASH YOUR HANDS THOROUGHLY AFTER HANDLING USED ENGINE OIL.

1. Unscrew and remove the oil filler cap/dipstick.

2. Place an oil collection tray under the drain plug.
3. Unscrew the drain plug and allow the used engine oil to drain from the crankcase into the oil collection tray.

**NOTE:** Drain the engine oil when the engine is warm, this will ensure the oil flows out faster.

4. Replace the drain plug.
5. Fill the crankcase with engine oil.
  - Fill until the oil reaches the threads in the oil fill tube.
  - Oil capacity (See page 20.).
  - We recommend the use of SAE15W40 oil in this generator. available from your CLARKE dealer.
6. Replace the dipstick.

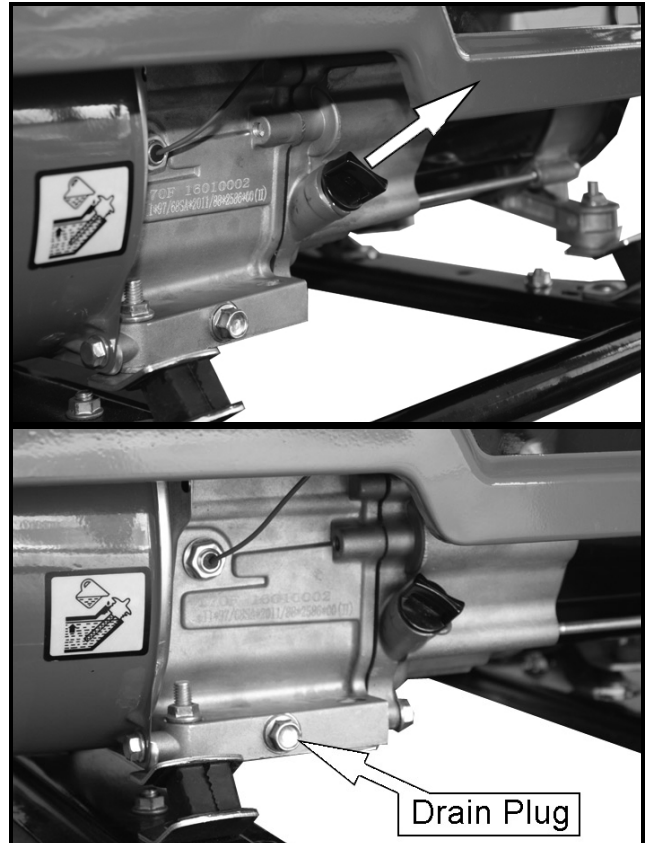

## ENVIRONMENTAL PROTECTION

One of the most damaging sources of pollution is oil, Do not throw away used engine oil in with your domestic rubbish or pour it down drains and sinks. Place it in a leak proof container and take it to your local waste disposal site.

## CHANGING THE SPARK PLUG



CAUTION: ALLOW THE ENGINE TO COOL BEFORE REMOVING THE SPARK PLUG.

1. Remove the spark plug cap from the spark plug.



2. Use the spark plug spanner supplied to remove the spark plug.
3. Remove any carbon that has accumulated around the electrode.



4. Check the spark plug gap (a), it should be between 0.7 and 0.8 mm, adjust if necessary.
5. Check the overall condition of the spark plug for erosion or pitting and replace if necessary.
6. Reinstall the spark plug and replace the spark plug cap.

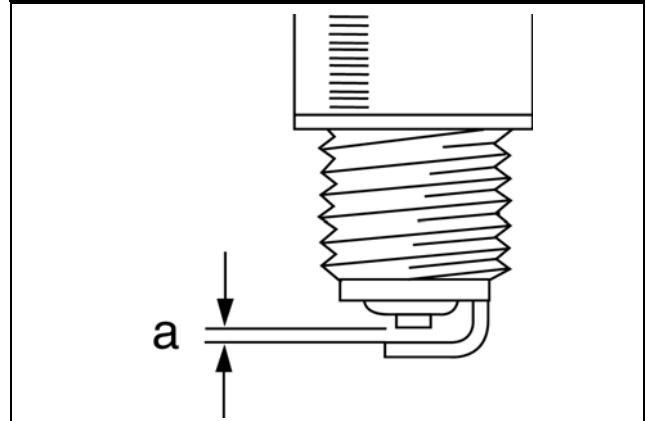



## CHECKING THE AIR FILTER



CAUTION: DO NOT USE THE GENERATOR WITHOUT THE AIR FILTER FITTED, THIS CAN DAMAGE THE GENERATOR.

1. Unclip and remove the air filter cover.

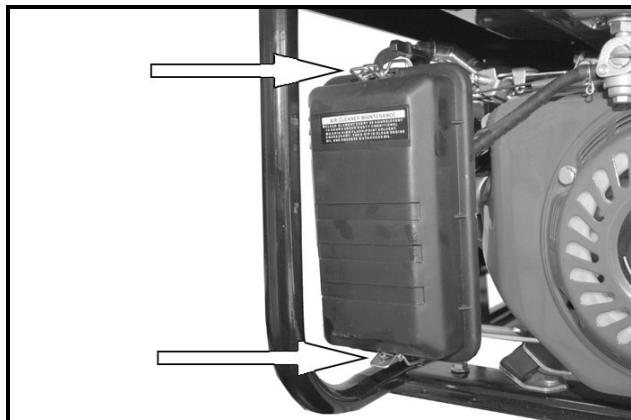

2. Remove the air filter element.

3. Make sure that the air filter is clean and not damaged.

- If the air filter is damaged contact CLARKE spare parts department for a replacement.

- If the filter is dirty, wash in a solution of warm water and mild detergent and rinse thoroughly. Leave the filter to dry completely, once it is dry immerse in clean engine oil and squeeze to remove excess oil.

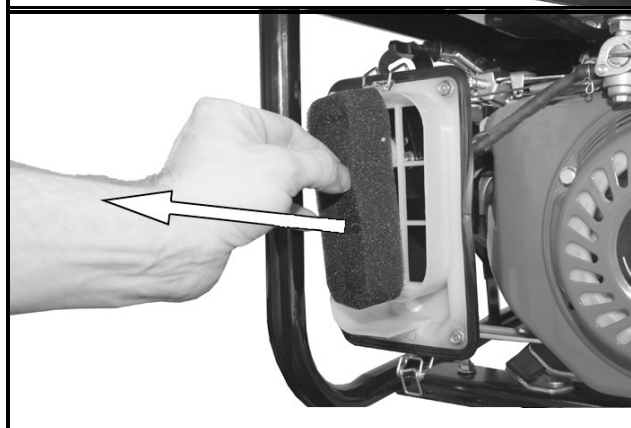

**WARNING: DO NOT USE INFLAMMABLE SOLVENTS OR PETROL TO CLEAN THE AIR FILTER.**

4. Replace the filter to its original position and replace the air filter cover.

## CLEANING THE FUEL VALVE FILTER / DRAINING THE FUEL TANK

1. Set the fuel supply valve to OFF.

2. Unscrew and remove the cup, then remove the valve filter and 'O' ring.

3. Wash these parts in a non-flammable solvent. Make sure that the valve filter is not damaged.

4. Place an approved petrol storage container under the fuel valve and set the fuel supply valve to 'ON'.

- The fuel in the tank will drain into the container.

5. Replace the 'O' ring and valve filter and tighten the cup as far as possible.

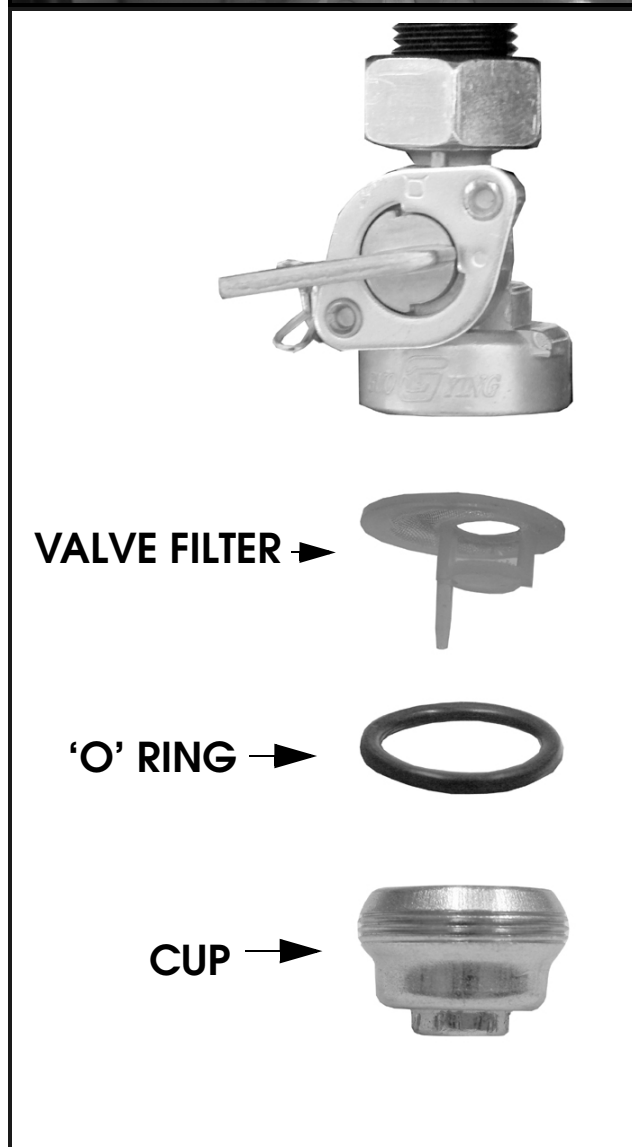
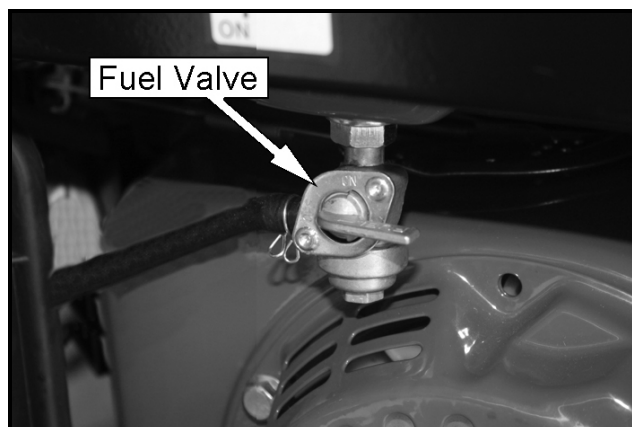

# TROUBLESHOOTING

PROBLEM	CAUSE	SOLUTION
The generator fails to start	Ignition switch is off	Set the ignition switch to 'on'
	Not enough oil in the generator	Add more oil, See page 8
	No fuel	Add more fuel, See page 9
	Spark plug not working correctly	Change the spark plug, See page 16
The generator fails to generate electricity	The device you are trying to power is faulty	Make sure the device you want to power is working properly
	The AC breaker is switched off	Switch the AC breaker on
The generator is difficult to start	The air filter is dirty	Clean the air filter, See page 17
	The fuel filter is blocked	Clean the fuel filter, See page 18

If this does not solve your problem, please contact the CLARKE service department.

# SPECIFICATIONS

		<b>PG3800A</b>
Engine	Engine Model	PT170F1
	Fuel Type	Petrol
	Displacement (cm <sup>3</sup> )	212 cc
	Max. power output (hp/rpm)	5.6 @ 3000 rpm
	Start system	Hand recoil
	Fuel tank capacity (L)	15
	Fuel consumption (L/hr.)	1.9
	Maximum run time (h) @75% Load	8.2
	Engine oil type	SAE15W40
	Engine oil capacity (L)	0.61
	Guaranteed sound power (LWA dB)	96
Generator	Rated Frequency (Hz)	50
	AC Output Voltage (V)	230 (13A)
	DC Output Voltage (V)	12V (Max 8.3A)
	Rated Power (W)	2700
Dimensions	Length (mm)	600
	Width (mm)	435
	Height (mm)	445
	Unpacked Weight (kg)	43.7

# EXPLODED DIAGRAM

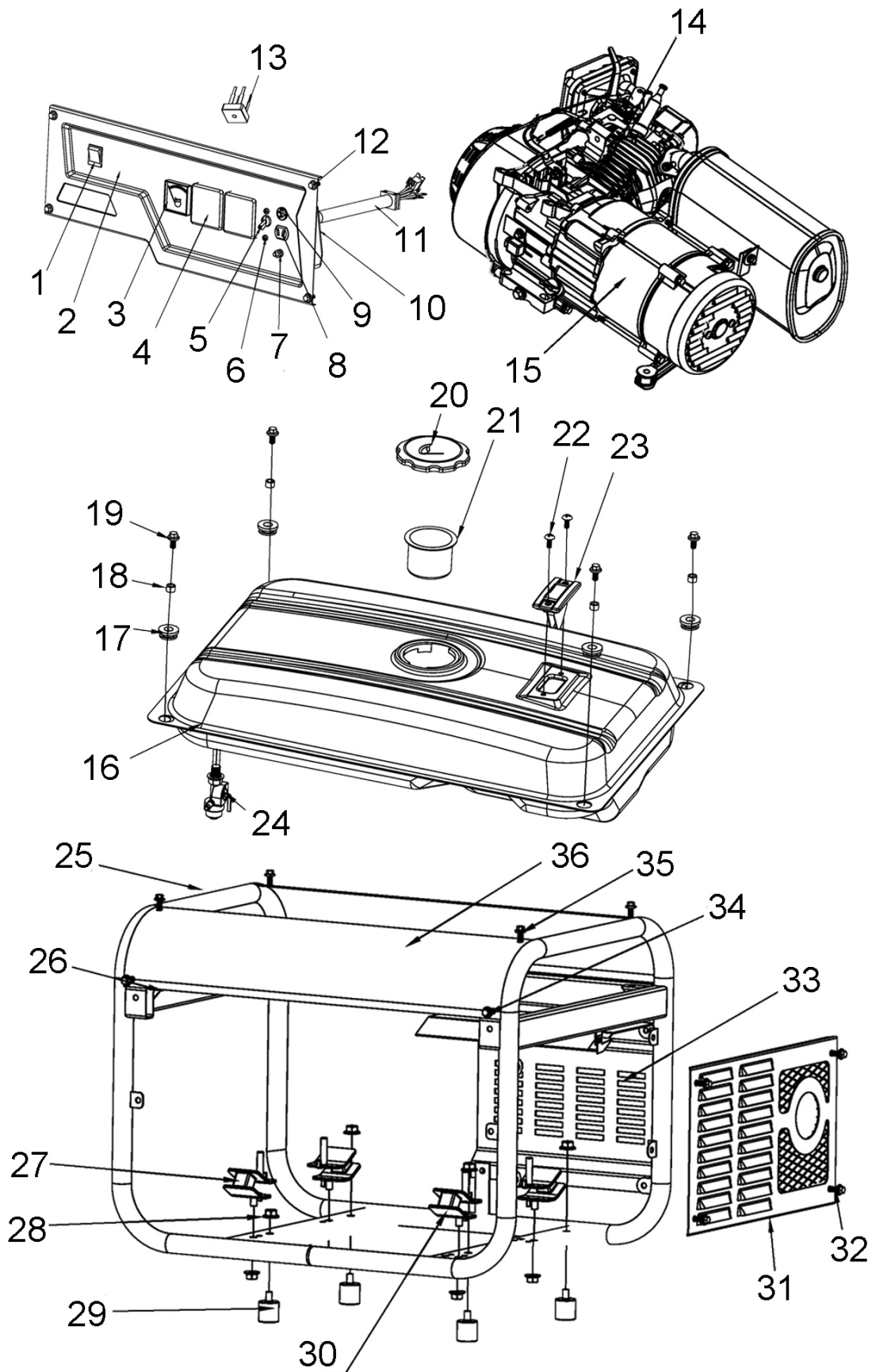

## PARTS LIST

No	Description	No	Description
1	Switch	19	Bolt M6x25
2	Panel	20	Fuel Filler Cap
3	Voltmeter	21	Fuel Filter
4	AC Socket	22	Screw M5x12
5	AC Breaker	23	Fuel Gauge
6	Screw M3x8	24	Fuel Valve
7	Earth Bolt	25	Frame
8	DC Socket	26	Cross Beam
9	DC Breaker	27	Anti Vibration Foot (LH)
10	Panel Back Cover	28	Flange Nut M8
11	Wiring Loom	29	Rubber Feet
12	Bolt M6x12	30	Anti Vibration Foot (RH)
13	Bridge Pile	31	Back Guard Plate
14	Engine	32	Flange Bolt M6x12
15	Generator	33	Side Guard Plate
16	Fuel Tank	34	Flange Bolt M6x12
17	Rubber Gasket	35	Flange Bolt M6x35
18	Washer	36	Upper Guard Plate

**Please quote the reference THPG380001 onwards. e.g. Fuel Filter will be THPG380021.**

# DECLARATION OF CONFORMITY



**Clarke**<sup>®</sup>  
INTERNATIONAL

Hemnal Street, Epping, Essex CM16 4LG

## DECLARATION OF CONFORMITY

This is an important document and should be retained.

**Product Description:** Petrol Powered Generator  
**Model number(s):** PG3800A  
**Serial / batch Number:** 8857852  
**Date of Issue:** 05/01/2023  
*(Noise Conformity)*  
**Notified Body:** N.B 0036  
TUV SUD Industrie Service GmbH  
Westendstrabe 199  
80686 Munchen  
Germany

**Technical Documentation Holder:** Alan Pond  
Clarke International Ltd  
Hemnal Street  
Epping  
Essex  
CM16 4LG  
UK

**Conformity Assessment Procedure:** To 2000/14/EC Annex V  
**Manufacturer:** Clarke International Ltd  
**Noise Related Value:** 2.7 kW  
**Measured Sound Power Level:** 94 dB  
**Guaranteed Sound Power Level:** 96 dB

PG3800A UKCA Clarke DOC 010523

Page 1 of 2



**Clarke**<sup>®</sup>  
INTERNATIONAL

Hemnal Street, Epping, Essex CM16 4LG

## DECLARATION OF CONFORMITY

This is an important document and should be retained.

We hereby declare that this product(s) complies with the following statutory requirement(s):

*Electromagnetic Compatibility Regulations 2016*  
*Supply of Machinery (Safety) Regulations 2008*  
*Noise Emission in the Environment by Equipment for Use Outdoors Regulations 2001*  
*The Non-Road Mobile Machinery (Type-approval and Emission of Gaseous and Particulate Pollutants) Regulations 2020*  
*The Restriction of the Use of Certain Hazardous Substances in Electrical and Electronic Equipment Regulations 2012*

The following standards have been applied to the product(s):

*EN 55012:2007/A1:2009, EN 61000-6-1:2007, EN IEC 61000-6-1:2009, EN ISO 8528-13:2016, EN 62321-1:2013, EN 62321-2:2014, EN 62321-3-1:2014, EN 62321-4:2014, EN 62321-5:2014, EN 62321-6:2015, EN 62321-7-1:2015, EN 62321-7-2:2017, EN 62321-8:2017*

The technical documentation required to demonstrate that the product(s) meet(s) the requirement(s) of the aforementioned legislation has been compiled and is available for inspection by the relevant enforcement authorities.

The UKCA mark was first applied in: 2023

Signed:

J.A. Clarke  
Director

PG3800A UKCA Clarke DOC 010523

Page 2 of 2



**Clarke**<sup>®</sup>  
INTERNATIONAL

Fitzwilliam Hall, Fitzwilliam Place, Dublin 2

## DECLARATION OF CONFORMITY

This is an important document and should be retained.

**Product Description:** Petrol Powered Generator  
**Model number(s):** PG3800A  
**Serial / batch Number:** 8857852  
**Date of Issue:** 05/01/2023  
*(Noise Conformity)*  
**Notified Body:** N.B 0036  
TUV SUD Industrie Service GmbH  
Westendstrabe 199  
80686 Munchen  
Germany

**Technical Documentation Holder:** Alan Pond  
Clarke International Ltd  
Hemnal Street  
Epping  
Essex  
CM16 4LG  
UK

**Conformity Assessment Procedure:** To 2000/14/EC Annex VI  
**Manufacturer:** Clarke International Ltd  
**Noise Related Value:** 2.7 kW  
**Measured Sound Power Level:** 94 dB  
**Guaranteed Sound Power Level:** 96 dB

PG3800A CE Clarke DOC 010523

Page 1 of 2



**Clarke**<sup>®</sup>  
INTERNATIONAL

Fitzwilliam Hall, Fitzwilliam Place, Dublin 2

## DECLARATION OF CONFORMITY

This is an important document and should be retained.

We hereby declare that this product(s) complies with the following directive(s):

*2014/30/EU Electromagnetic Compatibility Directive*  
*2006/42/EC Machinery Directive*  
*2000/14/EC Noise Emission Directive (amended by 2005/88/EC)*  
*2016/628/EU Emission of Gaseous Particulates Regulation (with Amendments)*  
*2011/65/EU The Restriction of the Use of Certain Hazardous Substances in Electrical and Electronic Equipment Directive*

The following standards have been applied to the product(s):

*EN 55012:2007/A1:2009, EN 61000-6-1:2007, EN IEC 61000-6-1:2009, EN ISO 8528-13:2016, EN 62321-1:2013, EN 62321-2:2014, EN 62321-3-1:2014, EN 62321-4:2014, EN 62321-5:2014, EN 62321-6:2015, EN 62321-7-1:2015, EN 62321-7-2:2017, EN 62321-8:2017.*

The technical documentation required to demonstrate that the product(s) meet(s) the requirement(s) of the aforementioned directive(s) has been compiled and is available for inspection by the relevant enforcement authorities.

The CE mark was first applied in: 2015

Signed:

J.A. Clarke  
Director

PG3800A CE Clarke DOC 010523

Page 2 of 2

# A SELECTION FROM THE VAST RANGE OF

# Clarke®

## QUALITY PRODUCTS



**AIR COMPRESSORS**  
From DIY to industrial, Plus air tools, spray guns and accessories.

**GENERATORS**  
Prime duty or emergency standby for business, home and leisure.

**POWER WASHERS**  
Hot and cold, electric and engine driven - we have what you need

**WELDERS**  
Mig, Arc, Tig and Spot. From DIY to auto/industrial.

**METALWORKING**  
Drills, grinders and saws for DIY and professional use.

**WOODWORKING**  
Saws, sanders, lathes, mortisers and dust extraction.

**HYDRAULICS**  
Cranes, body repair kits, transmission jacks for all types of workshop use.

**WATER PUMPS**  
Submersible, electric and engine driven for DIY, agriculture and industry.

**POWERTOOLS**  
Angle grinders, cordless drill sets, saws and sanders.

**STARTERS/CHARGERS**  
All sizes for car and commercial use.



## PARTS & SERVICE: 0208 988 7400

**Parts Enquiries**  
[Parts@clarkeinternational.com](mailto:Parts@clarkeinternational.com)

**Servicing & Technical Enquiries**  
[Service@clarkeinternational.com](mailto:Service@clarkeinternational.com)

SALES: UK 01992 565333 or Export 00 44 (0)1992 565335

**Clarke® INTERNATIONAL** Hemnall Street, Epping, Essex CM16 4LG  
[www.clarkeinternational.com](http://www.clarkeinternational.com)